

ELECTRIC SUNROOF

CONTENTS

Subject	Page No.
DESCRIPTION AND OPERATION:	
Description and Operation of Electric Sunroof	8E-54
DIAGNOSIS:	
Electric Sunroof Diagnosis	8E-56
MAINTENANCE AND ADJUSTMENTS:	
Panel Alignment - Front Left or Right	8E-56
Panel Alignment - Rear, Left or Right	8E-56
Ramp Alignment	8E-56
Panel Does Not Run True	8E-57
Cable Guide Alignment	8E-57
Maintenance	8E-57
MAJOR REPAIR:	
Headlining Panel Removal and Installation	8E-57
Sunroof Motor Removal and Installation	8E-58
Gear Box Assembly Removal and Installation	8E-58
Sunroof Panel Removal and Installation	8E-59
Rear Slide and Cable Removal and Installation	8E-60
Drain Hose Replacement	8E-61
Weatherstrip Removal and Installation	8E-62
SPECIFICATIONS: (Not Applicable)	

DESCRIPTION AND OPERATION

DESCRIPTION AND OPERATION OF ELECTRIC SUNROOF

The sunroof is actuated by a two-way electrical motor mounted near the center of the windshield header area. See Figure 8E-1.

The motor drives an auxiliary unit with a gear on the output shaft. This gear drives two flexible cables that attach to the sunroof panel and control its movement. See Figure 8E-2.

The electrical power for the sunroof is taken from the existing power window relay. From here the current is routed to two relays. Activating the switch ener-

gizes one of the relays, supplying current to the motor and then to ground. Activating the switch on the opposite direction activates the other relay and supplies a reverse current flow to the motor and then to ground. (Figures 8E-17 and 8E-18)

To open, place control switch in the open position to activate the motor. The roof panel will retract down and rearward, moving on guide rails, from the flush roof position back into a storage area between the headliner and roof.

To close, place control switch in the close position to activate the motor, the roof panel moves forward in the guide rails and, as it nears the end of its forward travel, the rear portion moves upward on two ramps. This positions the panel flush with the roof and seals it tightly in the opening.

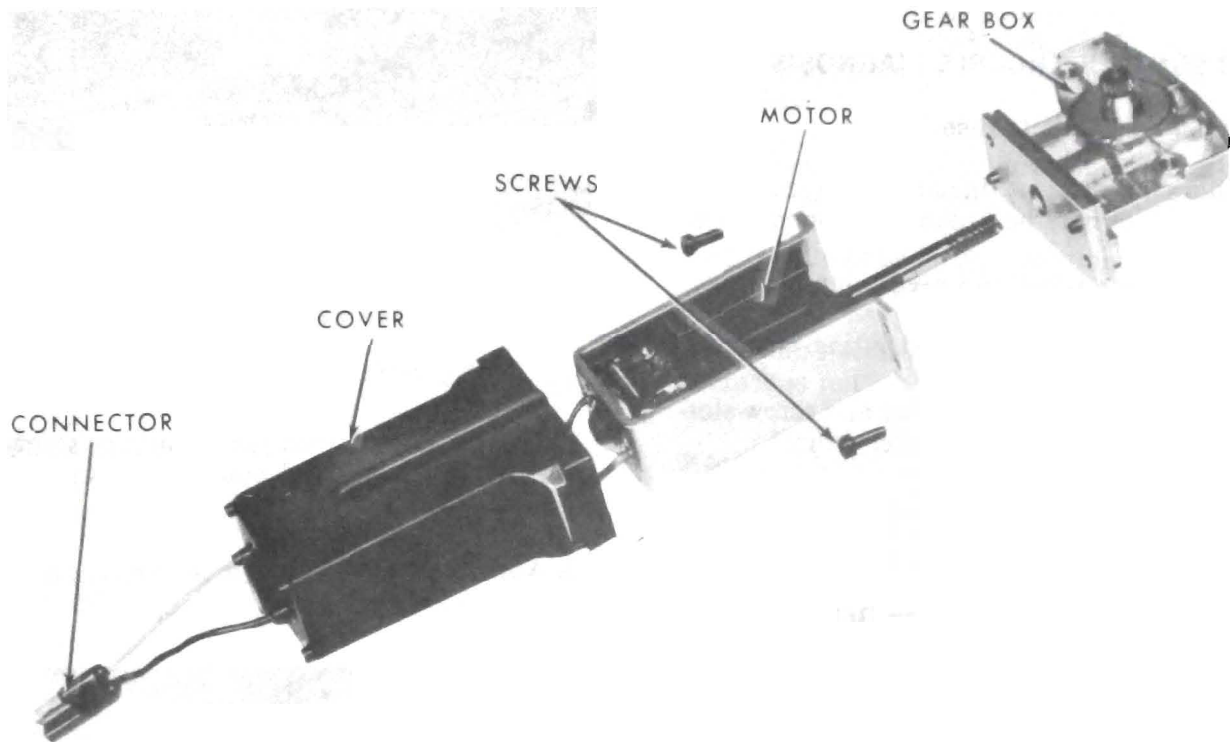

8E-1

Figure 8E-1 Motor and Drive Unit

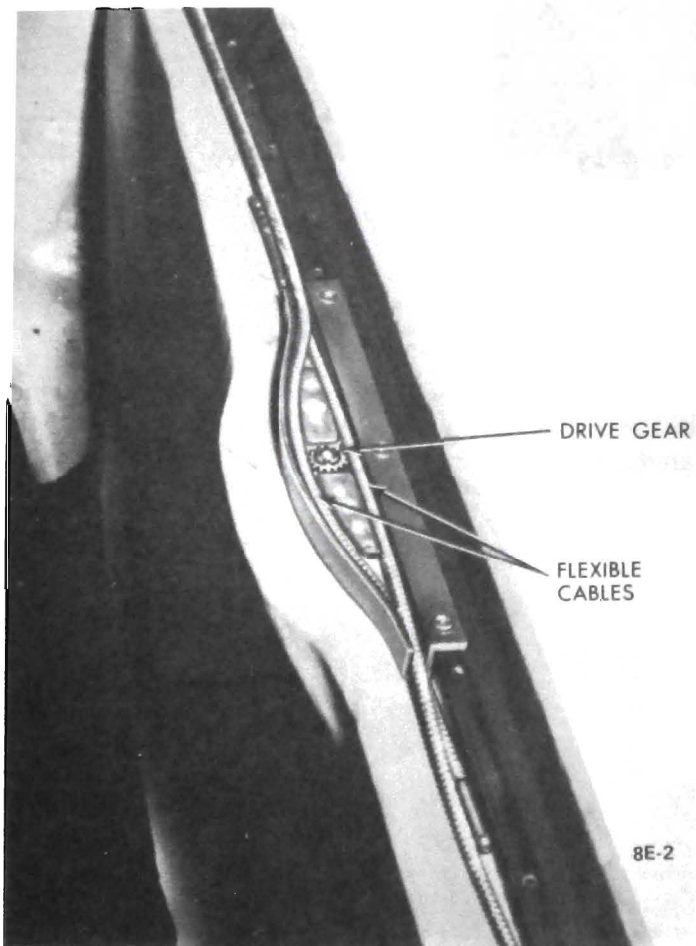

8E-2

Figure 8E-2 Drive Gear and Cables

There are four plastic drain tubes to drain off any water seepage past the weatherstrip. One tube is located in each of the windshield pillars that exhaust through the rocker panels, and one in each rear quarter panel that exhausts through the rear wheel housings.

In case of an electrical failure, the sunroof may be closed manually by using the following steps:

1. Remove plug located just in front of the sunroof opening (center area).
2. Remove screw located behind plug.

CAUTION: : *Observe the number of and type of washers when removing screw. The screw and washers provide adjustment for the auxiliary drive clutch and must be replaced exactly as they were removed.*

3. Using crank provided in glove box, insert threaded end into the socket of the winding gear and crank in a clockwise direction.

DIAGNOSIS

ELECTRIC SUNROOF TROUBLE DIAGNOSIS

Motor Runs, Panel Fails to Rise

1. Panel does not run true due to mechanical resistance. Drive cables may be broken or disconnected.
2. Front slides are tilted and need alignment.
3. Check alignment of ramp and lifting elements.
 - a. Remove winding gear access plug and screw slotted head screw. Add another washer (shim).
 - b. Replace screw, check operation, tighten screw and install plug.

Motor Fails to Run in One Direction Only

1. Reverse wiring of the two relays and activate switch.
2. If motor runs in opposite direction, a relay is defective.
3. If motor runs in same direction, switch is defective.

Motor Fails to Run

1. If power windows also fail to operate, check power window circuit breaker.
2. With test light, check voltage at the supply terminal of the relays.
3. Activate control switch and check voltage at the motor. Also check motor ground wire.
4. Replace motor.

MAINTENANCE AND ADJUSTMENTS

PANEL ALIGNMENT - FRONT, LEFT OR RIGHT

1. To obtain a flush fit, loosen both front slide screws. See Figure 8E-3.
2. Turn knurled nuts clockwise to raise panel and counterclockwise to lower panel. See Figure 8E-3.
3. Adjust opposite front slide the same. Tighten screws.

PANEL ALIGNMENT - REAR, LEFT OR RIGHT

1. To obtain a flush fit, loosen 3/8" lock nut on rear slide. See Figure 8E-4.

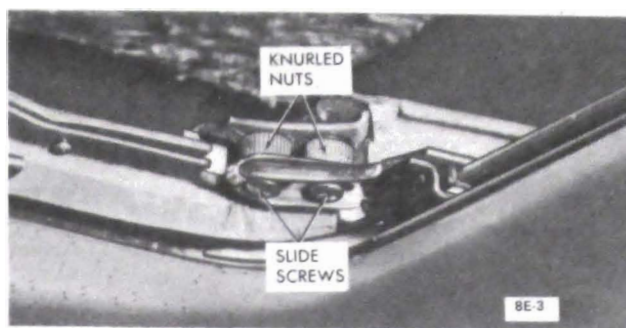

Figure 8E-3 Panel Alignment - Front

2. Using a screwdriver, turn adjusting screw clockwise to raise panel and counterclockwise to lower panel.
3. Adjust opposite rear slide the same. Tighten lock nut.

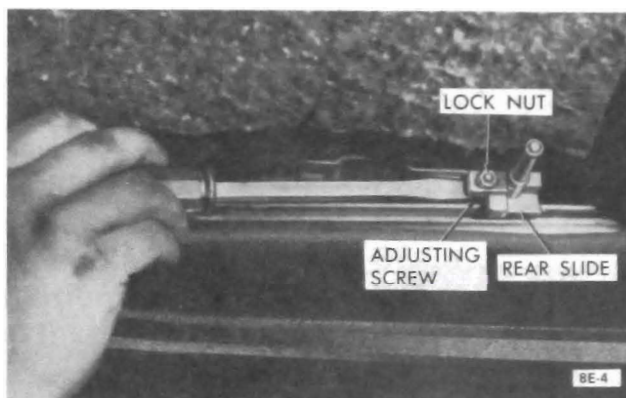

Figure 8E-4 Panel Alignment - Rear

RAMP ALIGNMENT

1. If roof panel does not raise into opening during closing cycle, remove headlining panel from roof panel and open panel to full position.

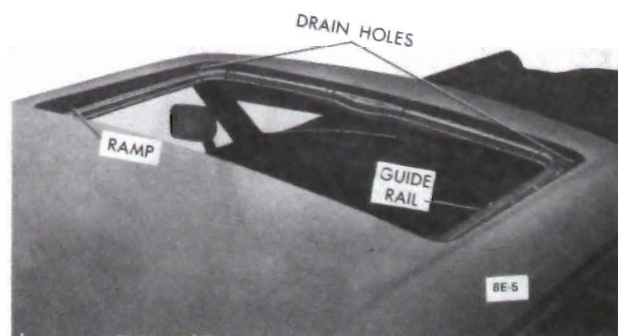

Figure 8E-5 Sunroof Fully Open

2. Examine ramps in drainage channel to determine proper alignment with lifting element at rear of panel. See Figure 8E-5. Point of contact between lifting element and ramp can be seen on rearward slope on ramp.

3. Pry ramp up and move ramp side to side until centered with lifting element.

4. Close roof panel and note lifting action of panel.

5. If necessary, readjust ramps up or down and side to side until proper lifting action of panel is obtained.

PANEL DOES NOT RUN TRUE

1. Close panel to determine which side jams.

2. Open panel, remove drive housing center cover and pry off drive cable retaining clip. See Figure 8E-6.

CAUTION: : *Clip is made of spring steel. Cover clip to prevent rapid spring-up.*

3. To move right side of roof panel forward, lift right cable at front of pinion and pull it one or more teeth to the left.

4. To move left side panel forward, perform same operation on left cable.

5. Install retaining clip and cover, check operation.

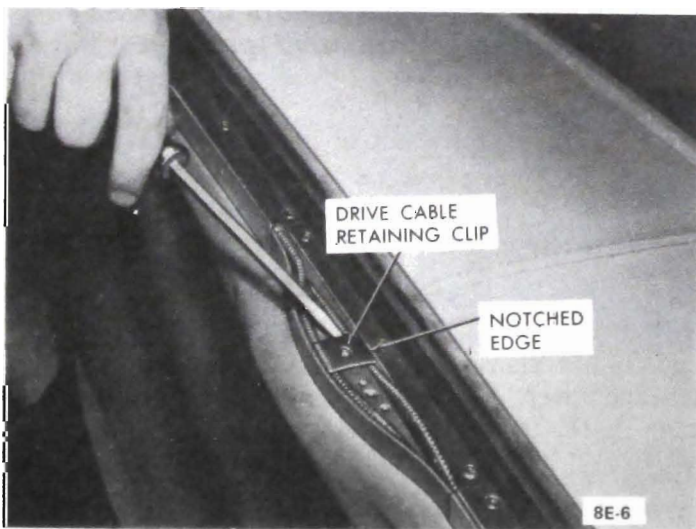

Figure 8E-6 Remove Drive Cable Retaining Clip

CABLE GUIDE ALIGNMENT

1. If panel jams, check both front corner lower elbow guides for alignment with front and side guides.

2. If necessary, shim lower elbow guides to move guides inboard for alignment with adjacent guides.

3. If panel fails to raise, the joints of cable slides are out of alignment (guide rail, corner and connector guides, and cable drive housing) and are jamming cable drive.

a. Loosen screws retaining the guide rails, corner and connector rails and cable drive housing.

b. Retighten one by one, continually activating the drive mechanism.

c. Where necessary, realign those points where resistance is felt.

MAINTENANCE

1. During cable replacement lubricate cables with No. 70 lubriplate or equivalent.

2. Periodically clean off any dirt on guide rail covers. Do not lubricate top surface of guide rail covers as this will streak headlining.

3. Check drain holes at front. If plugged, clean with compressed air or flexible wire. Clean rear tubes from the bottom of tubes. If the tubes cannot be opened up, replace them.

MAJOR REPAIR

HEADLINING PANEL REMOVAL AND INSTALLATION

Removal

1. Open roof panel approximately 3 inches.
2. Remove 2 screws securing headlining panel.
3. Slide headlining panel forward and out of retaining clips. See Figure 8E-7.
4. Retract roof panel to full open position.
5. Remove headlining panel reinforcement bow by removing tape from bow and sliding bow rearward and off the headlining material. See Figure 8E-8.
6. Close roof panel approximately 3 inches to permit headlining frame to clear roof panel rear hooks.
7. Pull headlining panel forward and out of side guide rail lower tracks.

Installation

1. Retract roof panel to full open position.

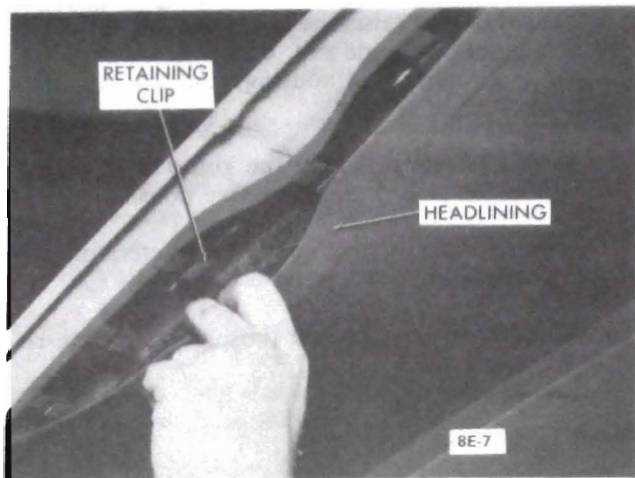

Figure 8E-7 Headlining Panel Removal



Figure 8E-8 Removing Bow

2. Align headlining panel with side guide rail lower tracks and move rearward into proper position.
3. Install reinforcement bow.
4. Close roof panel all but approximately 3 inches.
5. Install headlining panel and secure retaining clips.
6. Install securing screws in panel.

SUNROOF MOTOR REMOVAL AND INSTALLATION

Removal

1. Open sunroof to full open position and disconnect negative battery cable.
2. Remove all windshield garnish moldings, sunvisors and brackets and carefully loosen headlining material from front roof inner panel.
3. Disconnect electrical connector.

4. Remove cover off back of motor to expose mounting screws and remove motor.

Installation

1. Position motor to gear box using existing guide pins.
2. Secure motor to gear box and reinstall motor cover.
3. Connect electrical connector.
4. Carefully reinstall headlining material using trim cement, to front roof inner panel.
5. Install all garnish molding, sunvisor brackets and sunvisors. Be careful not to pinch drain tubes when installing garnish moldings.

GEAR BOX ASSEMBLY REMOVAL AND INSTALLATION

Removal

1. Gain access to sunroof motor and disconnect wiring (use motor removal procedure).
2. Remove drive cable housing cover and right and left elbow corner guides.
3. Carefully remove drive cable retaining clip.

CAUTION: : *The clip is made of spring steel. Cover clip to prevent rapid spring-up.*

4. Pull drive cables out of upper and lower front guides.
5. Remove drive cable housing.
6. Remove gear box assembly along with motor.
7. Gently clamp gear box in a padded vise and remove cover. Then, using an Allen wrench, disengage motor from gear box.

Installation

1. With gear box gently clamped in a padded vise, using guide pins, position motor to gear box and secure, then install cover.
2. Install motor and gear box assembly to drive cable housing, then install drive cable housing.
3. Insert ends of cables in guides, then lubricate cables and drive gear (No. 70 grade lubriplate, or equivalent).

4. Install elbow corner guides. Alignment of lower elbow corner guide is of utmost importance.

6. Connect wiring and check operation of system.

7. Install foam insulation padding, headlining material, garnish moldings and sunvisors and brackets. Be careful not to pinch drain tubes when installing garnish moldings.

SUNROOF PANEL REMOVAL AND INSTALLATION

Removal

1. Open sunroof approximately three inches.
2. Remove screws from front of headlining panel that secures it to roof panel.
3. Slide panel forward and out of retaining clips on panel front edge. Close roof and push headlining panel to full rearward position. See Figure 8E-7.
4. Remove outboard screws from each front slide assembly. See Figure 8E-9.
5. Loosen inboard slide screw, rotate each front slide assembly inboard to clear guide rail. See Figure 8E-10.
6. Pull each rear slide and cable assembly inboard and out of slide retainer hole in roof panel. See Figure 8E-11.
7. Lift roof panel at front edge and pull forward and out of opening.

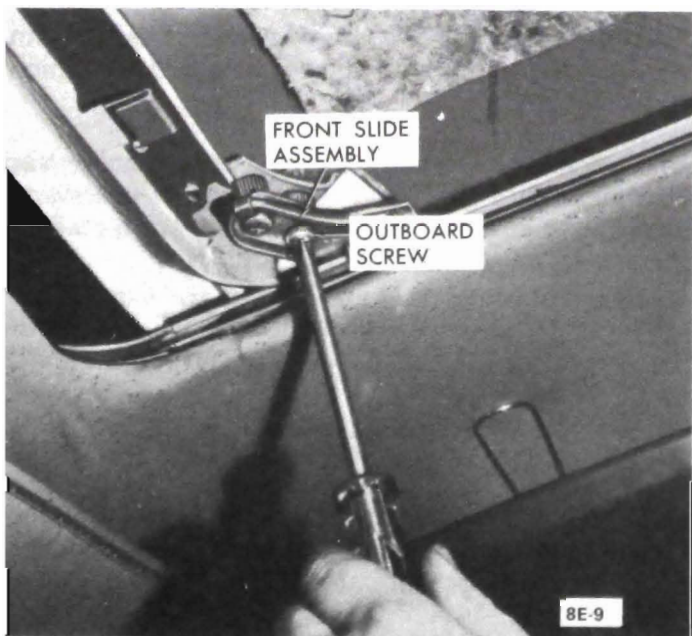

Figure 8E-9 Remove Outboard Screw From Front Slide Assembly

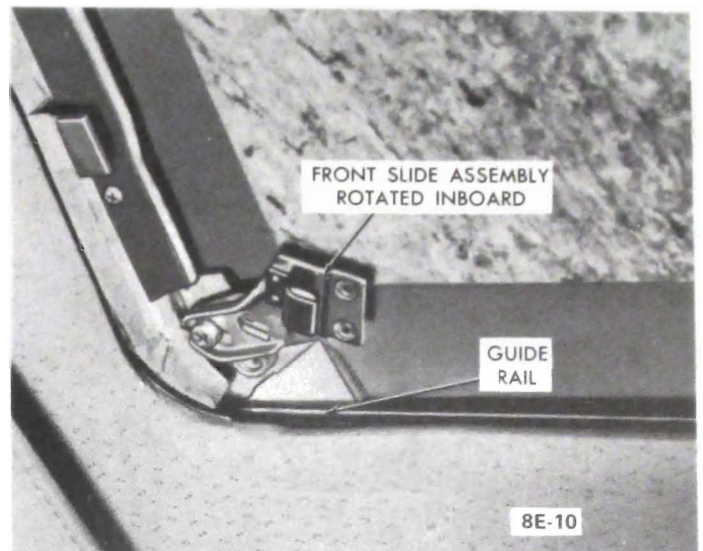

Figure 8E-10 Front Slide Assembly Clear of Guide Rail

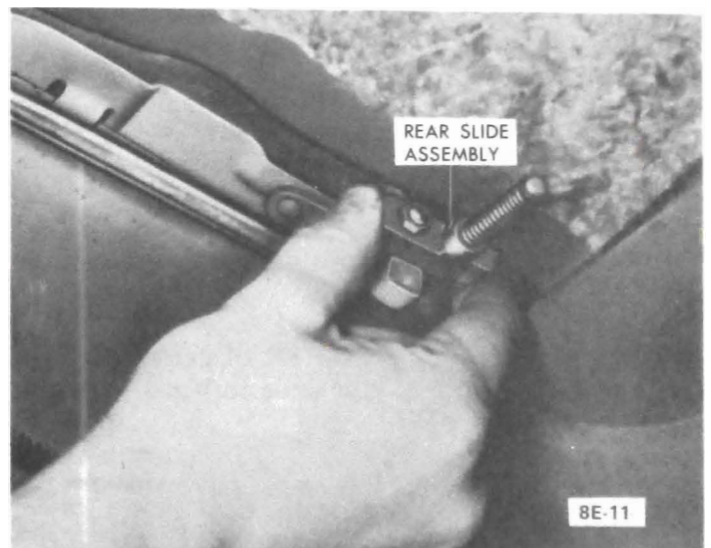

Figure 8E-11 Removing Rear Slide Cable Assembly From Retainer

Installation

1. With headlining panel in full rearward position, install roof panel into roof opening.

CAUTION: *Hold panel in horizontal position when placing panel into roof opening to assure that stop on center, rear edge of roof panel does not damage passenger compartment headlining.*

2. Move each front slide assembly outboard and install slides on guide rail upper tracks.
3. Install outboard screws and tighten both on each side. See Figure 8E-3.
4. Push roof panel to full forward position.
5. Lift rear of panel upward and activate switch to

position. Rear slides into alignment with holes on slide retainers on roof panel. See Figure 8E-11.

6. Engage each rear slide pin into retainer hole and install retainer spring plate on slide pin.
7. Actuate switch, check operation of roof panel and note fit. Adjust if necessary.
8. Install headlining on roof panel.

REAR SLIDE AND CABLE REMOVAL AND INSTALLATION

Removal

If only one cable is defective, replace both to assure parallel travel on roof panel.

1. Remove drive cable housing cover.
2. Remove both front upper elbow guides.
3. Using screwdriver, pry off drive cable retaining clip. See Figure 8E-6.
4. Pull free end of one cable out of guide rail and housing, pull cable and rear slide forward to front corner. See Figure 8E-12.
5. Remove slide from guide track, pull cable out of front guide. See Figure 8E-13.
6. Remove opposite cable in same manner.

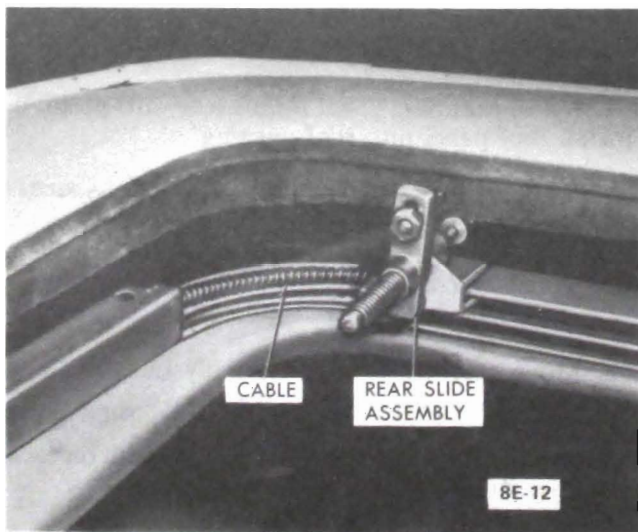

Figure 8E-12 Pull Cable and Slide Assembly Forward

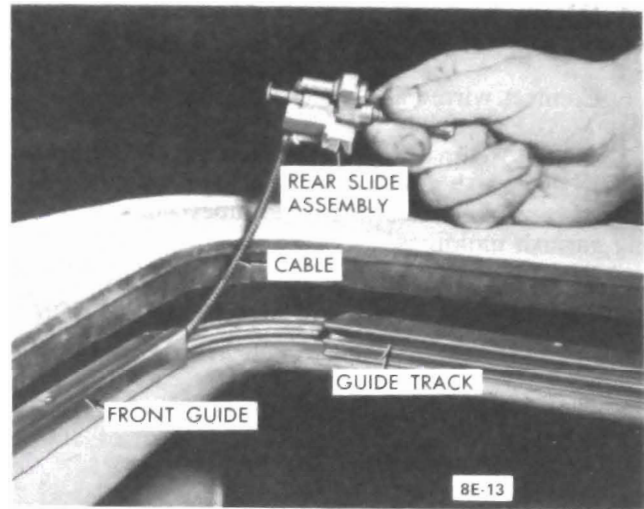

Figure 8E-13 Slide Removed

Installation

1. Position left rear slide in guide track, move slide and cable back until slide is centered with the fifth side guide rail screw from front. See Figure 8E-14.
2. Slide free end of cable into upper front guide, route through the curved front center track in drive cable housing and into lower track on right side. Do not engage cable in drive pinion teeth. See Figures 8E-15 and 8E-16.
3. Install right slide and cable in same manner as left, except that right cable is routed in straight center track of housing and into lower track on left side. See Figure 8E-16.

Make sure right side is centered with fifth screw from right guide rail. Do not engage cable in drive pinion teeth.

4. Check both front corner lower elbow guides for alignment with front and side guides. If necessary, shim lower elbow guide to move inboard for alignment with adjacent guides.
5. Lube cables at elbow areas with No. 70 grade lubripalte, or equivalent. Install both front corner upper elbow guides.
6. Recheck position of rear slides (fifth screw from front on side guide rail). See Figure 8E-14. With slides in this position, engage cables in drive pinion teeth. This operation is critical to assure roof panel alignment and prevent cable breakage.
4. Check both front corner lower elbow guides for alignment with front and side guides. If necessary shim lower elbow guide to move inboard for alignment with adjacent guides.

5. Lube cables at elbow areas with No. 70 grade lubriplate, or equivalent. Install both front corner upper elbow guides.

6. Recheck position of rear slides (fifth screw from front on side guide rail). See Figure 8E-14. With slides in this position, engage cables in drive pinion teeth. This operation is critical to assure roof panel alignment and prevent cable breakage.

7. Lubricate cables and pinion teeth with No. 70 grade lubriplate, or equivalent, install drive cable retaining clip. Position narrow (notched) edge of clips toward front of vehicle.

8. Install drive cable housing cover.

9. Actuate switch to assure operation, then return rear slides to fifth screw from front on side guide rails.

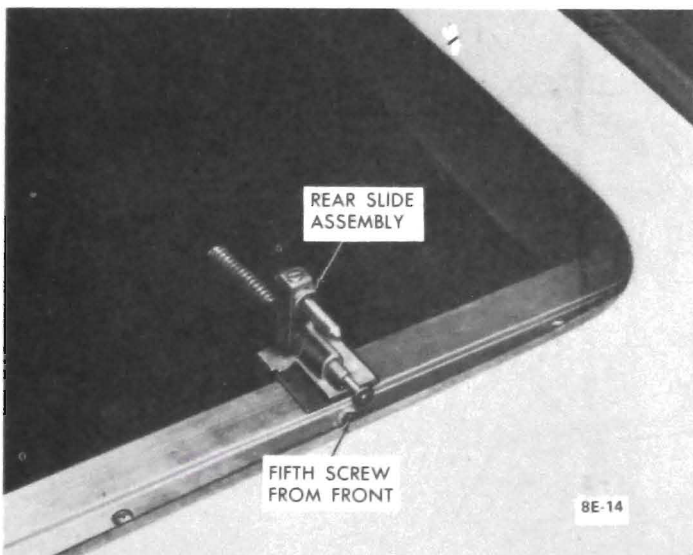

Figure 8E-14 Rear Slide in Centered Position

DRAIN HOSE REPLACEMENT

Front Drain Hose

1. Remove windshield side garnish moldings, roof side rail garnish moldings, both sunvisor assemblies, counter bracket and both windshield upper garnish moldings.

2. Carefully pull headlining from top of windshield area to gain access to hose.

3. Remove hose from outlet at top. Adhesive is used to secure hose to outlet.

4. Use a piece of flexible wire or cord, attach new hose to lower end of old and pull new into position while removing old hose and secure with weather-strip adhesive.

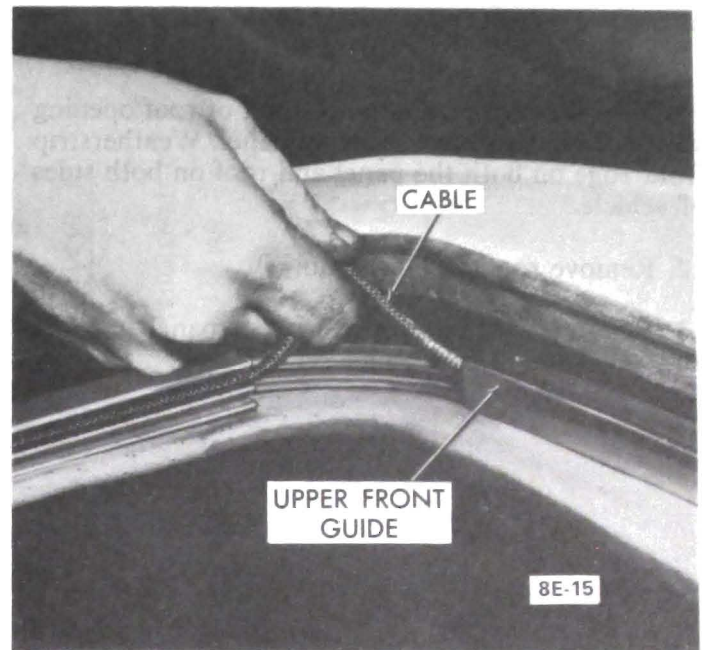

Figure 8E-15 Installing Cable Into Upper Front Guide

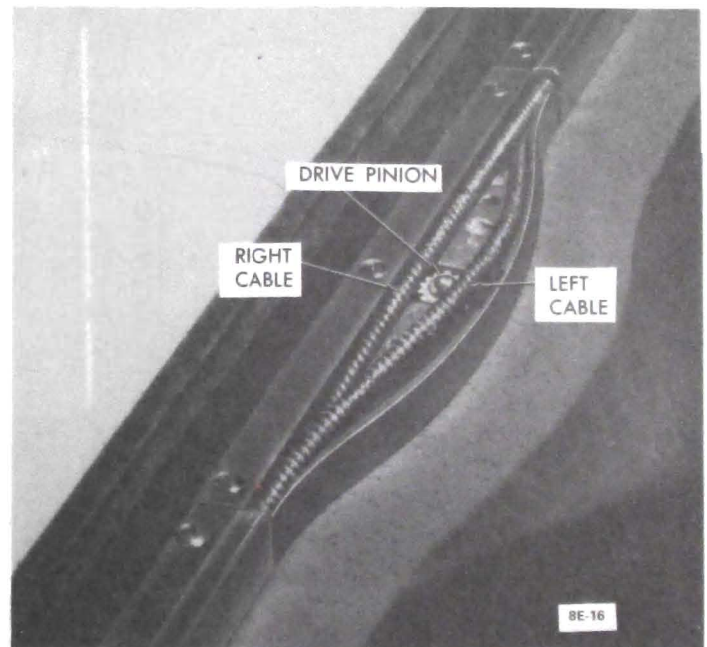

Figure 8E-16 Drive Cables Installed

5. Reinstall headlining, garnish moldings, sunvisor assemblies and center bracket.

Rear Drain Hose

1. Pull down headlining at rear corner to gain access.

2. Remove hose at top.

3. Using a piece of flexible wire or cord, attach new to lower end of old and pull new into position.

WEATHERSTRIP REMOVAL AND INSTALLATION

1. With sunroof closed, mark joint of roof opening weatherstrip rear edge and roof panel. Weatherstrip front edge on both the panel and roof on both sides of vehicle.
2. Remove roof panel assembly.
3. Remove weatherstrip from roof panel opening and rear edge of roof panel.
4. Clean surface, using a suitable solvent, and apply weatherstrip cement to both surfaces.
5. Position roof opening weatherstrip flush with roof and align one end of weatherstrip with mark on roof assembly. Cement weatherstrip to roof opening.
6. Install weatherstrip on rear edge in same manner. Also retained with trim nails.
7. Install roof panel, assembly into opening.

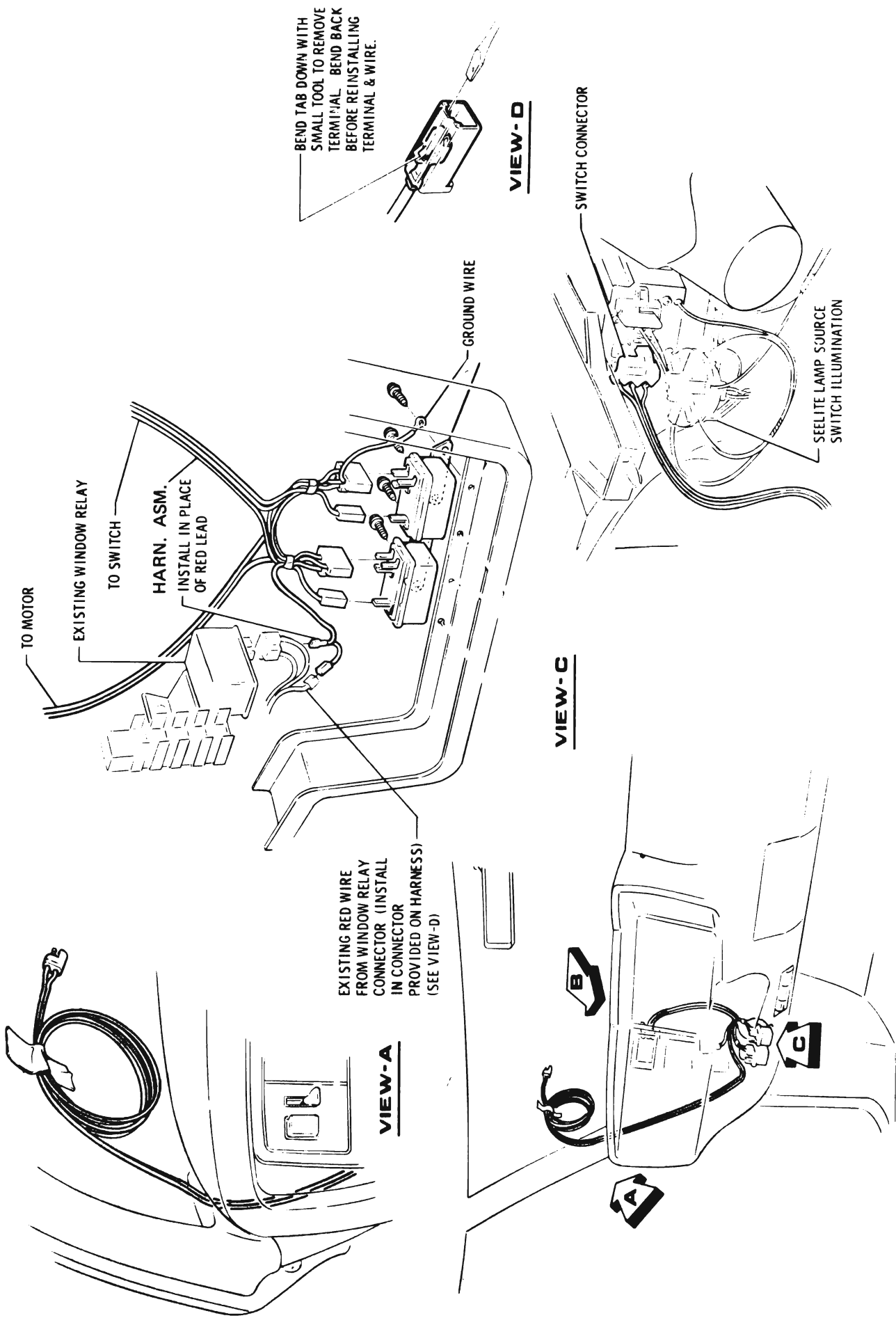

8E-17

Figure 8E-17 Sunroof Wiring

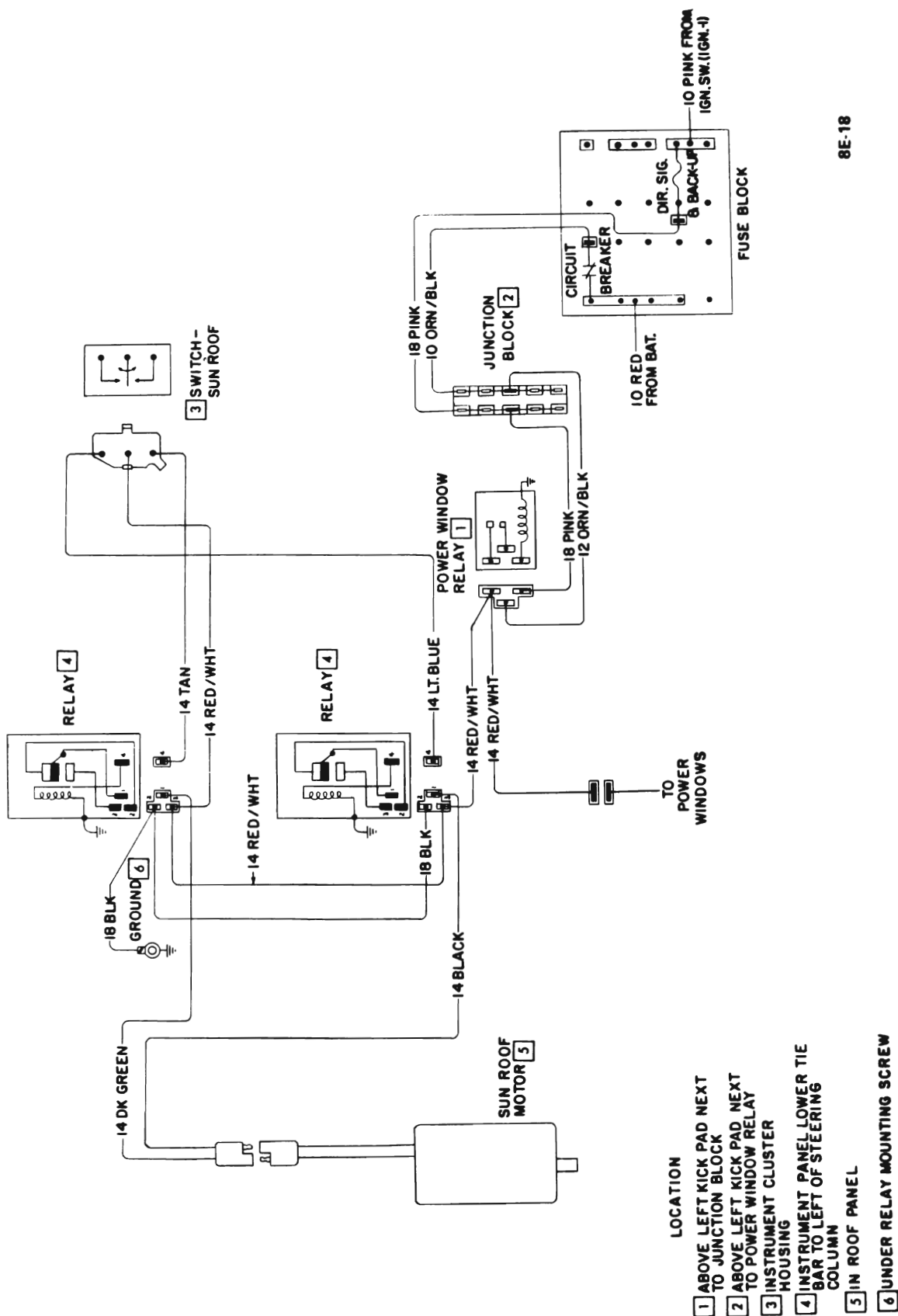

8E-18

Figure 8E-18 Sunroof Wiring Diagram

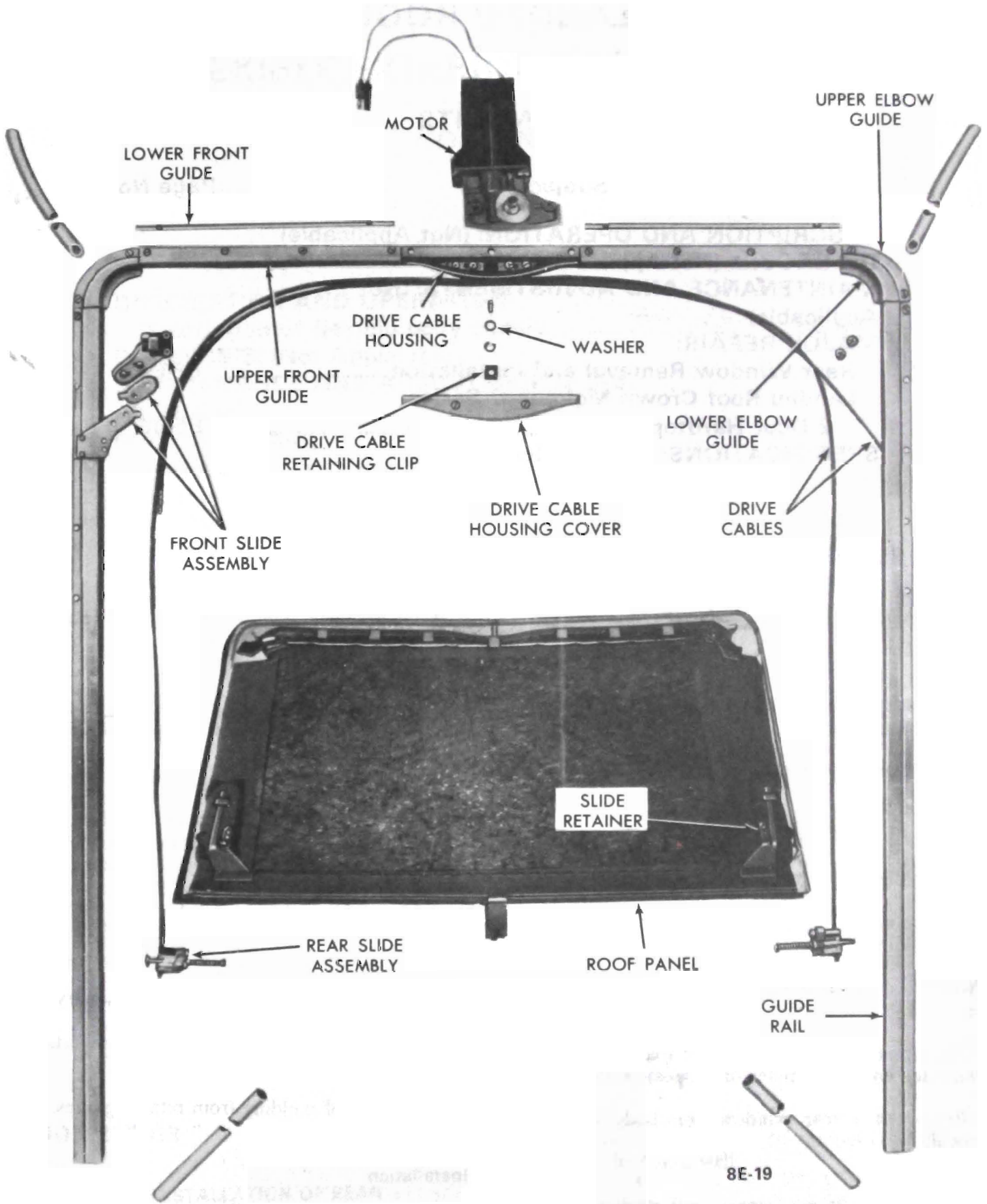

8E-19

Figure 8E-19 Sunroof Exploded View